



INTAKE SYSTEMS FOR VEHICLES LISTED ARE 50 STATE LEGAL. SEE KNFILTERS.COM FOR CARB STATUS ON EACH PART FOR A SPECIFIC VEHICLE.

# INSTALLATION INSTRUCTIONS

## 77-3034KP CHEVROLET / GMC

2001-04 Silverado 2500 HD / 3500  
2001-04 Sierra 2500 HD / 3500  
V8-6.6L Turbo Diesel (exc. LLY)

**NOTE:** This kit was not designed to fit vehicles with a body lift.

**TOOLS NEEDED:**

- Flat Blade Screwdriver
- Phillips Screwdriver
- Pliers
- 3mm Allen Wrench
- 10mm wrench
- Ratchet
- Extension
- 10mm Socket
- 13mm Socket

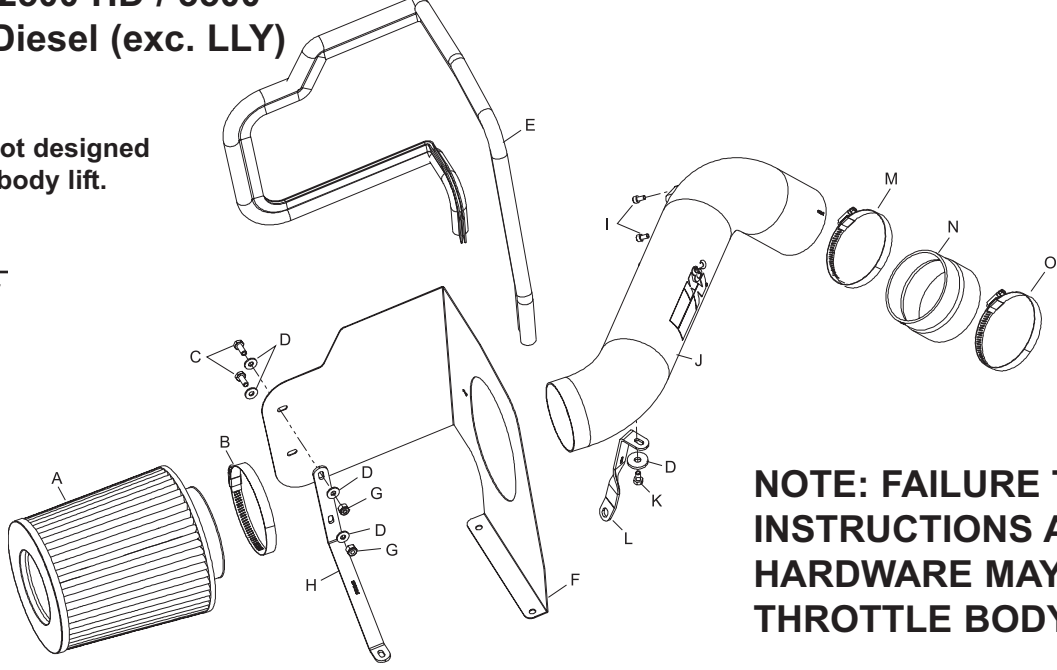

**PARTS LIST:**

Description	Qty.	Part #
A Air Filter	1	RC-5112
B Hose Clamp, #60	1	08624
C Bolt, 6mm x 16mm L, Hex, SS	2	07812
D Washer, 6mm Flat	5	08269
E Edge Trim, 3/4" Bulb, 50" L	1	102481
F Heat Shield	1	07457
G Nut, 6mm Nylock, SS	2	07512
H Bracket, "C"	1	070025
I Bolt, 4mm x 8mm L, C/H/A, SS	2	07733
J Performance Intake Tube	1	27354
K Bolt, 6mm x 12mm L, Hex, SS	1	07727
L Bracket, Twist	1	010066
M Hose Clamp, #52	1	08610
N Hose, Silicone Step	1	084090
O Hose Clamp, #56	1	08620

**NOTE: FAILURE TO FOLLOW INSTALLATION INSTRUCTIONS AND NOT USING THE PROVIDED HARDWARE MAY DAMAGE THE INTAKE TUBE, THROTTLE BODY AND ENGINE.**

**TO START:**

1. Turn the ignition OFF and disconnect the vehicle's negative battery cable.  
**NOTE: Disconnecting the negative battery cable erases pre-programmed electronic memories. Write down all memory settings before disconnecting the negative battery cable. Some radios will require an anti-theft code to be entered after the battery is reconnected. The anti-theft code is typically supplied with your owner's manual. In the event your vehicles' anti-theft code cannot be recovered, contact an authorized dealership to obtain your vehicles anti-theft code.**



2. Disconnect the mass air sensor electrical connection.



3. On 2001 models remove the 8mm bolt that secures the engine cover, then remove the cover.

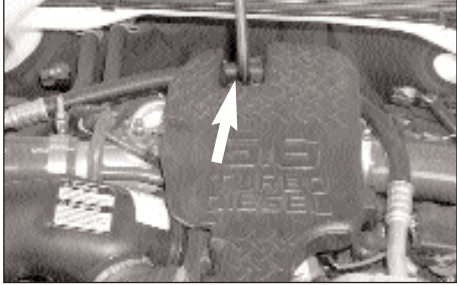

4. On 2002 models remove the torx bolt from the intake resonator as shown.



5. Loosen the hose clamp at the intake resonator, then, remove the resonator as shown.

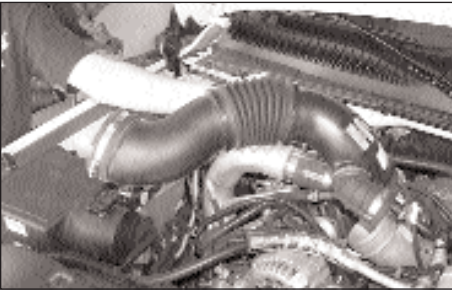

6. Loosen the hose clamp at the intake manifold and at the air cleaner then remove the stock intake tube as shown.



7. Pull firmly upwards to remove the stock air cleaner as shown.  
**NOTE: K&N recommends that you do not discard your factory air intake.**



8. Remove the mass air sensor from the stock air cleaner assembly as shown.

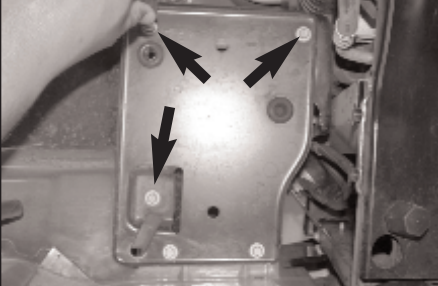

9. Remove the three air cleaner support tray bolts as shown.

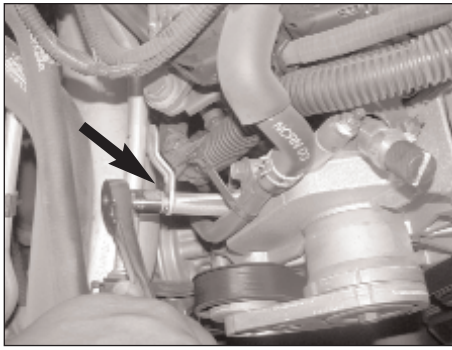

10. Remove the air conditioning hard line bolt as shown.

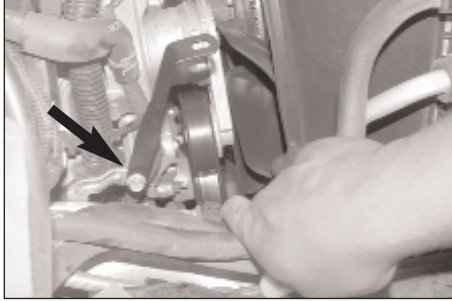

11. Using the bolt removed in step 10 secure the provided twist bracket to the original threaded boss as shown but do not tighten completely at this time.

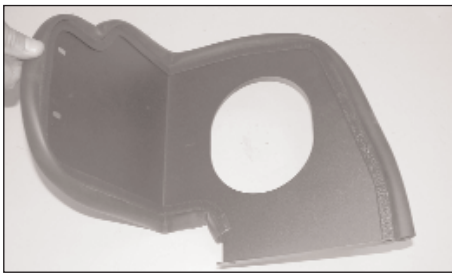

12. Install the provided trim seal onto the K&N heat shield and trim to fit as shown.

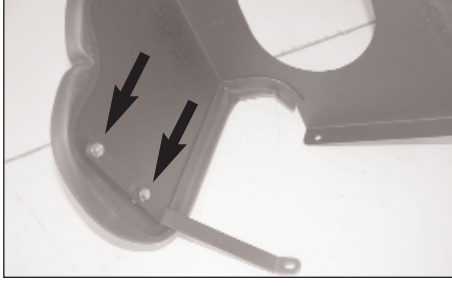

13. Using the provided hardware install the "C" bracket onto the heat shield as shown but do not tighten completely at this time.

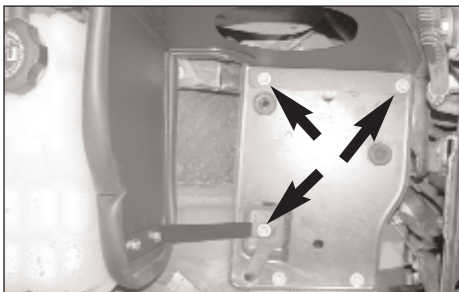

14. Install the heat shield into the vehicle and secure with the stock bolts from step 9 as shown but do not tighten completely at this time.

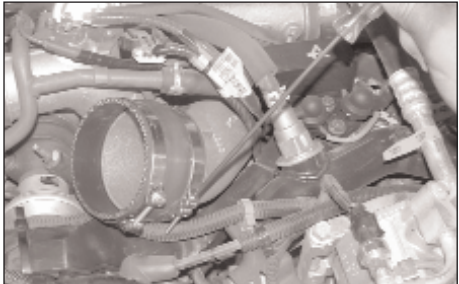

15. Install the silicone hose and hose clamps onto the turbocharger inlet tube as shown.



16. Install the mass air sensor into the K&N® intake tube and secure with the provided screws as shown.

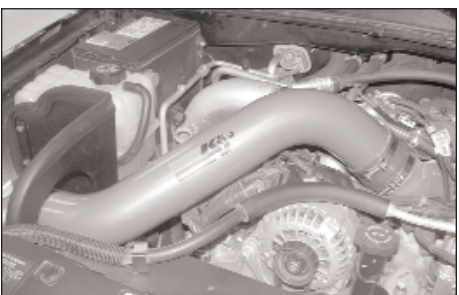

17. Slide the K&N® intake tube through the hole in the heat shield, then, slide the other end of the tube into the silicone hose as shown.

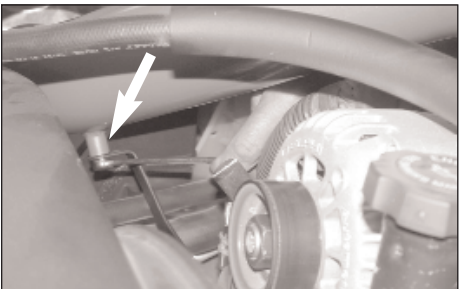

18. Line up the twist bracket from step 11 with the threaded boss on the K&N® intake tube and secure with the provided hardware as shown.



19. Remove the stock restriction gauge from the stock air cleaner as shown.



20. Remove the grommet from the stock air cleaner as shown.

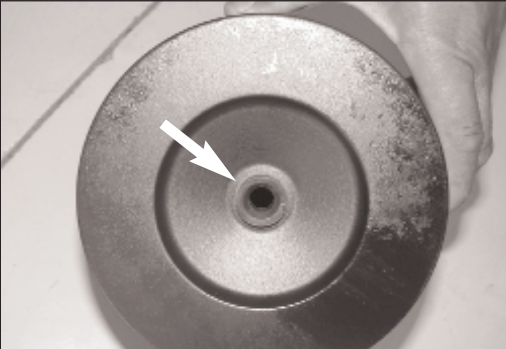

21. Install the grommet from step 20 into the hole on the end of the K&N® Air Filter as shown.



22. Install the restriction gauge into the grommet on the K&N® Air Filter as shown.

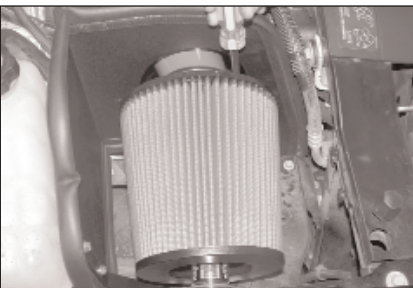

23. Install the K&N® Air Filter onto the K&N® intake tube and secure with the provided hose clamp as shown.

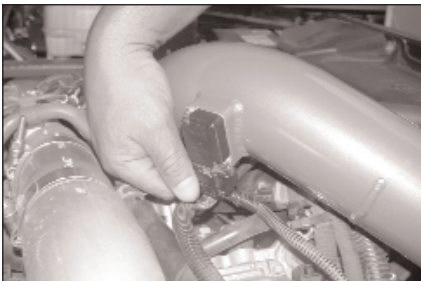

24. Reconnect the mass air sensor electrical connection as shown.

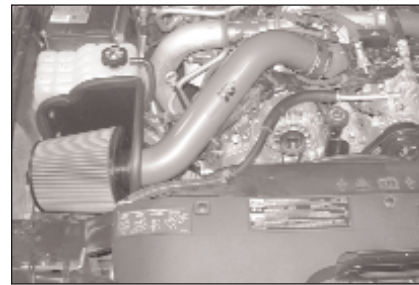

25. Reconnect the negative battery cable and double check to make sure everything is tightened and properly positioned before starting the vehicle.

26. The C.A.R.B. exemption sticker, (attached), must be visible under the hood so that an emissions inspector can see it when the vehicle is required to be tested for emissions. California requires testing every two years, other states may vary.

27. It will be necessary for all 77 series to be checked periodically for realignment, clearance and tightening of all connections. Failure to follow the above instructions or proper maintenance may void warranty.

#### ROAD TESTING:

1. Start the engine with the transmission in neutral or park, and the parking brake engaged. Listen for air leaks or odd noises. For air leaks secure hoses and connections. For odd noises, find cause and repair before proceeding. This kit will function identically to the factory system except for being louder and much more responsive.

2. Test drive the vehicle. Listen for odd noises or rattles and fix as necessary.

3. If road test is fine, you can now enjoy the added power and performance from your kit.

4. K&N suggests checking the Air Filter element periodically for excessive dirt build-up. When the element becomes covered in dirt (or once a year), service it according to the instructions on the Recharger service kit, part number 99-5000 or 99-5050.

#### IMPORTANT:

**Service air filter according to the K&N cleaning instructions (99-5050) when the indicator on the restriction gauge reaches the last two lines in the green. Do not run the vehicle with the yellow indicator in the red, as damage to the air filter and or engine could result.**

**INTAKE SYSTEMS FOR VEHICLES LISTED ARE 50 STATE LEGAL. SEE KNFILTERS.COM FOR CARB STATUS ON EACH PART FOR A SPECIFIC VEHICLE.**