



# TYPHOON INTAKE SYSTEMS

INTAKE SYSTEMS FOR VEHICLES LISTED ARE 50 STATE LEGAL. SEE KNFILTERS.COM FOR CARB STATUS ON EACH PART FOR A SPECIFIC VEHICLE.

## INSTALLATION INSTRUCTIONS

### 69-3517TS FORD 2012-14 Focus L4-2.0L

NOTE: EXCLUDING LEV2 SULEV  
2012-14 TEST GROUPS CFMXV02.0VZ2,  
DFMXV02.0VZ2 & EFMXV02.0VZ2

- TOOLS NEEDED:**
- 4mm Allen Wrench
  - 8mm Socket
  - 10mm Socket
  - Extension
  - Flat Blade Screwdriver
  - Ratchet

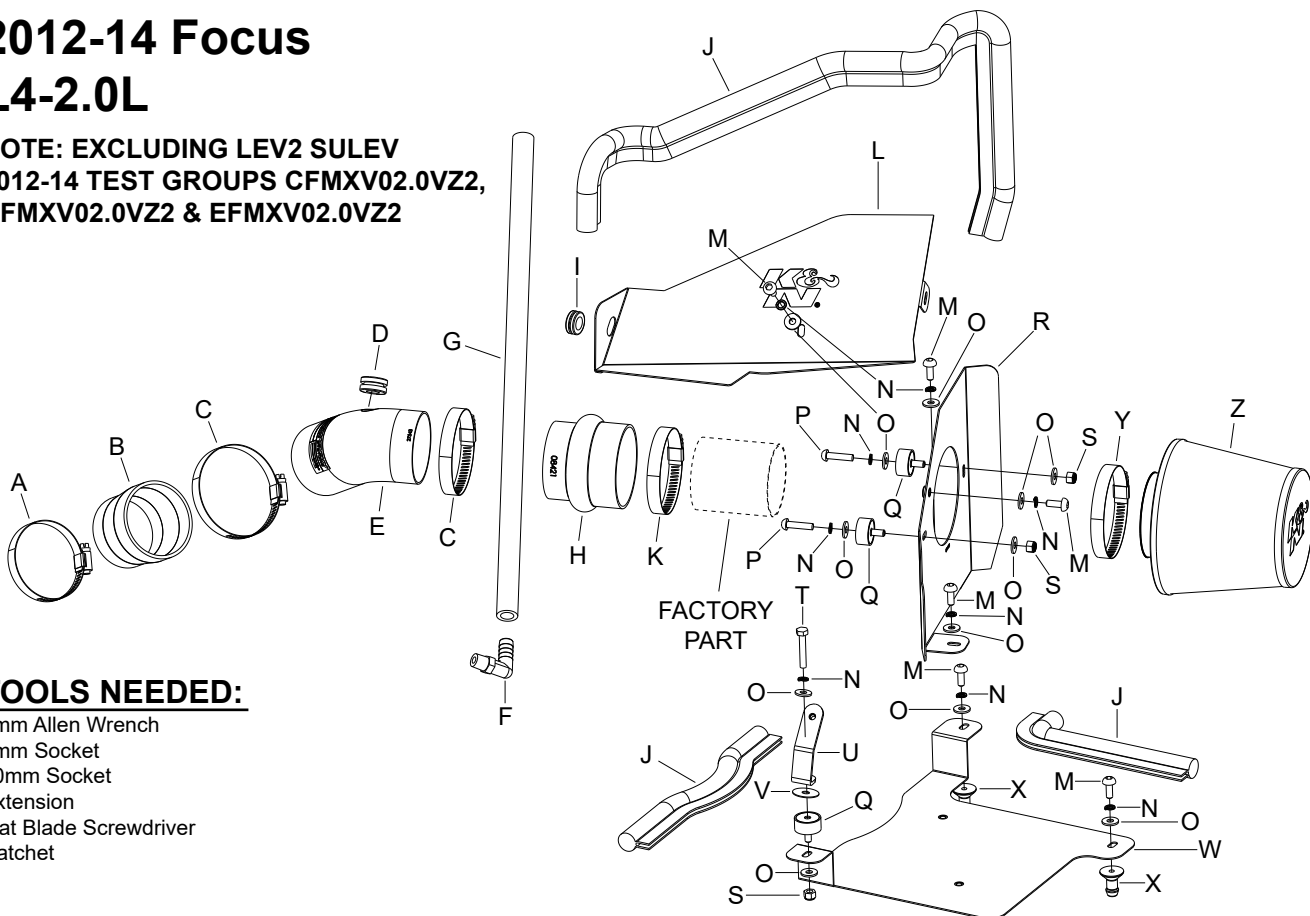

PARTS LIST:			
	Description	Qty.	Part #
A	Hose Clamp #40	1	08554
B	Hose; 2-3/4" To 2-1/2"ID	1	084016
C	Hose Clamp #44 Stainless	2	08560
D	Grommet; 1"OD, 1/2"ID, 1/2" Thk.	1	08064
E	Tube; 2.75"OD X 5.5"L	1	27543
F	Vent; 90°, 1/2"Hose, 1/4"NPT	1	08110FK
G	Hose; 1/2" X 24"L	1	08642
H	Hose; 3" To 2-3/4" X 3"L Hump	1	08421
I	Grommet; .875ODX.50ID	1	08063
J	Edge Trim (55")	1	102480
K	Hose Clamp #48	1	08601
L	Heat Shield; Fresh Air, Mild STL	1	074100
M	Bolt; M6 X 1.00 X 16mm, SS	6	07730
N	Washer; M6 Split Lock Zinc	9	1-3025
O	Washer; 6mm Flat, SS	12	08269
P	Bolt; M6-1.00 X 25mm SS	2	07729
Q	Stud; Rubber MNT, M/F, 1/2"L	3	070228
R	Heat Shield; Side, Mild STL,	1	074101
S	Nut; 6mm Nylock, Hexhead, SS	3	07512
T	Bolt; HEX M6-1 X 35mm	1	1-2002
U	Bracket; "C", STL TB/PC	1	083161
V	Washer; 1"D X 1/4 Hole Fender	1	08160
W	Heat Shield; Mild STL, TB/PC	1	074102
X	Nipple; Heat Shield Mount	2	8-186
Y	Hose Clamp # 44	1	08577
Z	Air Filter	1	RC-5284

If you need any assistance please call 1-800-858-3333 to speak with a representative in our Customer Service Center before returning the product.

**NOTE: FAILURE TO FOLLOW INSTALLATION INSTRUCTIONS AND NOT USING THE PROVIDED HARDWARE MAY DAMAGE THE INTAKE TUBE, THROTTLE BODY AND ENGINE.**

#### TO START:

1. Turn off the ignition and disconnect the negative battery cable.

**NOTE: Disconnecting the negative battery cable erases pre-programmed electronic memories. Write down all memory settings before disconnecting the negative battery cable. Some radios will require an anti-theft code to be entered after the battery is reconnected. The anti-theft code is typically supplied with your owner's manual. In the event your vehicles' anti-theft code cannot be recovered, contact an authorized dealership to obtain your vehicles anti-theft code.**



2. Release the red locking tab and then disconnect the mass air sensor electrical connection. Also unhook the mass air sensor wiring harness clip from the mass air sensor.

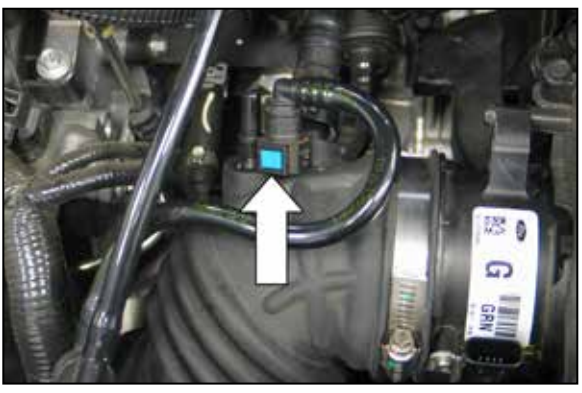

3. Depress the blue locking tab and then disconnect the EVAP vent line.

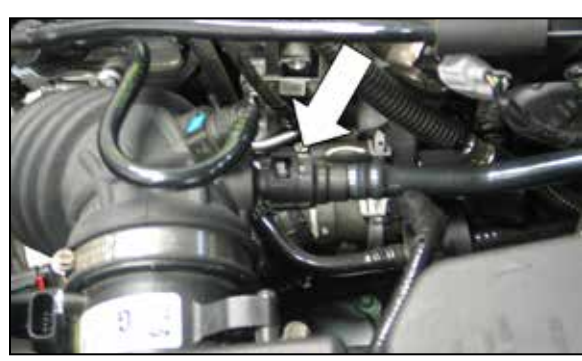

4. Disconnect the crank case vent line from the intake tube.



5. Disconnect the crank case vent hose from the valve cover and then remove the vent hose from the vehicle.



6. Loosen the hose clamp securing the intake tube to the throttle body.



7. Release the rubber strap securing the fresh air intake scoop to the duct.



8. Lift up the air box assembly to release it from the mounting grommets; remove the air box from the vehicle.



9. Remove the rubber fresh air duct from the vehicle.  
**NOTE: K&N Engineering, Inc., recommends that customers do not discard factory air intake.**



10. Remove the bolt shown securing the intake silencer to the inner fender; lift up to remove the intake silencer from the vehicle.



11. Install the provided silicone hose (084016) onto the throttle body and secure with the provided hose clamp.

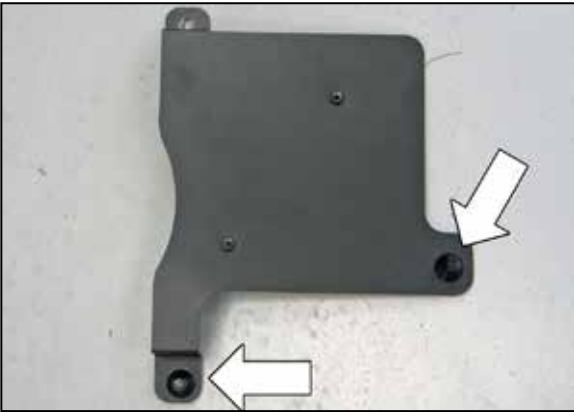

12. Install the two provided mounting studs onto the heat shield using the provided hardware.

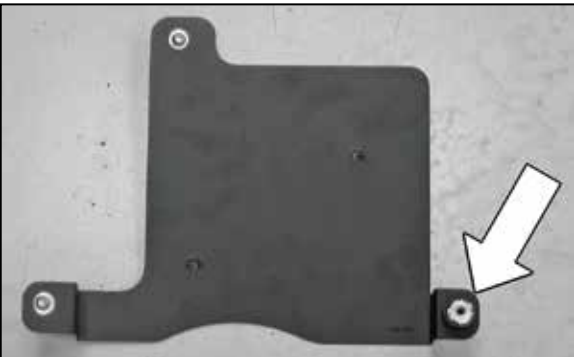

13. Install the provided rubber mounted stud onto the heat shield as shown using the provided hardware.

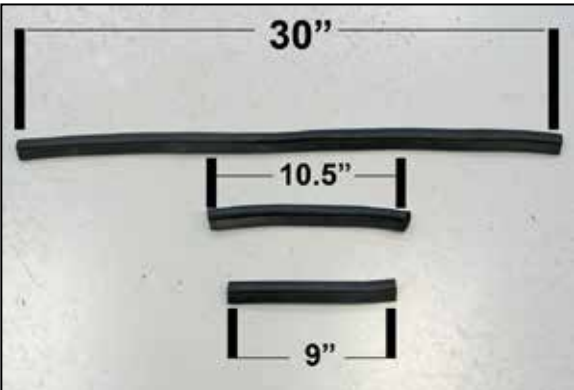

14. Cut the provided edge trim into three sections, 30" long, 10.5" long and 9" long.

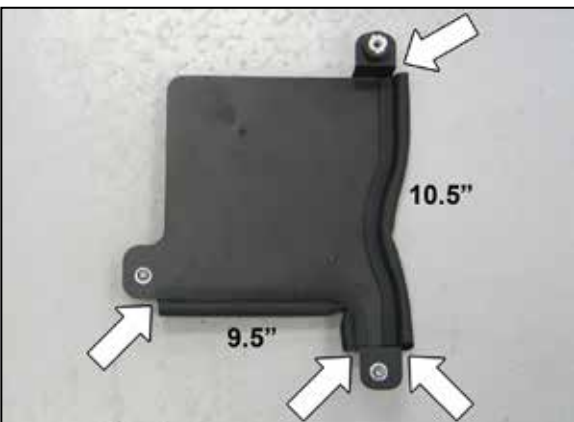

15. Install the 9" and 10.5" sections of edge trim onto the heat shield base as shown.



16. Set the heat shield base into position on the air box mounts.



17. Place the provided fender washer onto the fresh air intake scoop mount as shown.



18. Using the provided hardware, secure the provided bracket (083161) to the fresh air intake scoop mount and the rubber mounted stud on the heat shield base.

**NOTE: The provided fender washer from the previous step should be placed between the bracket and the fresh air intake scoop mount.**

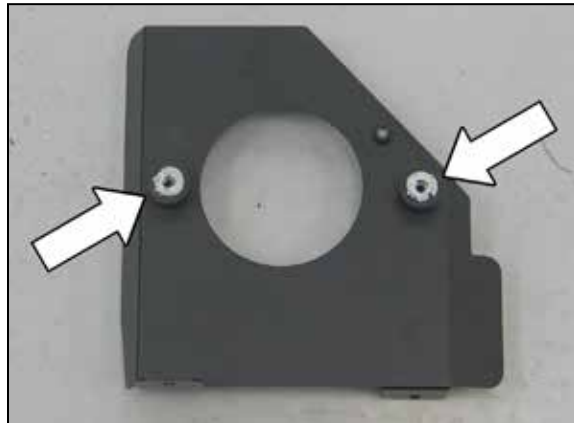

19. Install the provided rubber mounted studs onto the heat shield as shown.



20. Loosen the hose clamp that secures the factory intake tube to the mass air sensor housing and then remove the hose from the mass air housing.



21. Remove the two bolts securing the mass air sensor housing to the air box; separate the mass air housing from the air box.



22. Secure the mass air sensor housing to the rubber mounted studs on the heat shield as shown using the provided hardware.

**NOTE: The provided bolts will need to be threaded through the holes in the mass air sensor.**



23. Install the provided hump hose (08421) onto the mass air sensor as shown and secure with the provided hose clamp.



24. Install the provided 1.0"OD grommet into the K&N® intake tube as shown.



25. Install the 90° vent fitting into the K&N® intake tube as shown.

**NOTE: Plastic NPT fittings are easy to cross thread. Install the vent fitting "hand" tight, then turn it two complete turns with a wrench.**



26. Install the K&N® intake tube completely into the silicone hump hose and then set the complete assembly onto the heat shield base.



27. Install the K&N® intake tube into the silicone hose on the throttle body, then align the heat shield and secure with the provided hardware. Align the intake tube and secure with the provided hose clamps.



28. Install the provided silicone vent hose onto the 90° vent fitting in the K&N® intake tube and attach the open end to the valve cover port as shown.



29. Remove the EVAP fitting from the intake hose.



30. Install the EVAP fitting into the intake tube and then connect the EVAP vent line.

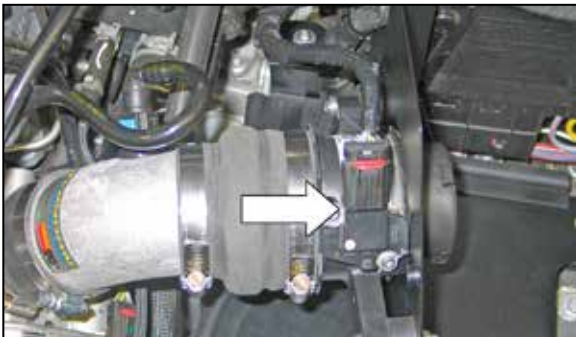

31. Reconnect the mass air sensor electrical connection.



32. Disconnect the hood release cable from the hood latch.



33. Install the provided 7/8"OD grommet into the K&N® fresh air plate as shown.



34. Pass the hood release cable through the grommet installed into the K&N® fresh air plate and then secure the fresh air plate to the heat shield and mounting bracket with the provided hardware. Reinstall the hood release cable to the hood latch.



35. Install the 30" long section of edge trim onto the fresh air plate and heat shield as shown. Some trimming of the edge trim will be necessary.



36. Install the K&N® air filter and secure with the provided hose clamp.

**NOTE: Do not over tighten the air filter hose clamp as crush damage to the mass air sensor housing will occur.**



37. Reconnect the vehicle's negative battery cable. Double check to make sure everything is tight and properly positioned before starting the vehicle.

38. The C.A.R.B. exemption sticker, (attached), must be visible under the hood so that an emissions inspector can see it when the vehicle is required to be tested for emissions. California requires testing every two years, other states may vary.

39. It will be necessary for all K&N® high flow intake systems to be checked periodically for realignment, clearance and tightening of all connections. Failure to follow the above instructions or proper maintenance may void warranty.

#### ROAD TESTING:

1. Start the engine with the transmission in neutral or park, and the parking brake engaged. Listen for air leaks or odd noises. For air leaks secure hoses and connections. For odd noises, find cause and repair before proceeding. This kit will function identically to the factory system except for being louder and much more responsive.

2. Test drive the vehicle. Listen for odd noises or rattles and fix as necessary.

3. If road test is fine, you can now enjoy the added power and performance from your kit.

4. K&N Engineering, Inc., requires cleaning the intake system's air filter element every 100,000 miles. When used in dusty or off-road environments, our filters will require cleaning more often. We recommend that you visually inspect your filter once every 25,000 miles to determine if the screen is still visible. When the screen is no longer visible some place on the filter element, it is time to clean it. To clean and re-oil, purchase our filter Recharger® service kit, part number 99-5050 or 99-5000 and follow the easy instructions.

**INTAKE SYSTEMS FOR VEHICLES LISTED ARE 50 STATE LEGAL. SEE KNFILTERS.COM FOR CARB STATUS ON EACH PART FOR A SPECIFIC VEHICLE.**