

TYPHOON INTAKE SYSTEMS



INSTALLATION INSTRUCTIONS

69-0015

Acura

2002-06 RSX, (exc. Type-S)

L4-2.0L

Honda

2002-04 CR-V

L4-2.4L

NOTE: C.A.R.B. E.O.# D-269-32
ONLY APPLIES TO 2002-05 ACURA
RSX.

TOOLS NEEDED:

Ratchet
6" extension
8mm socket
10mm socket
Flat blade screwdriver
Pliers

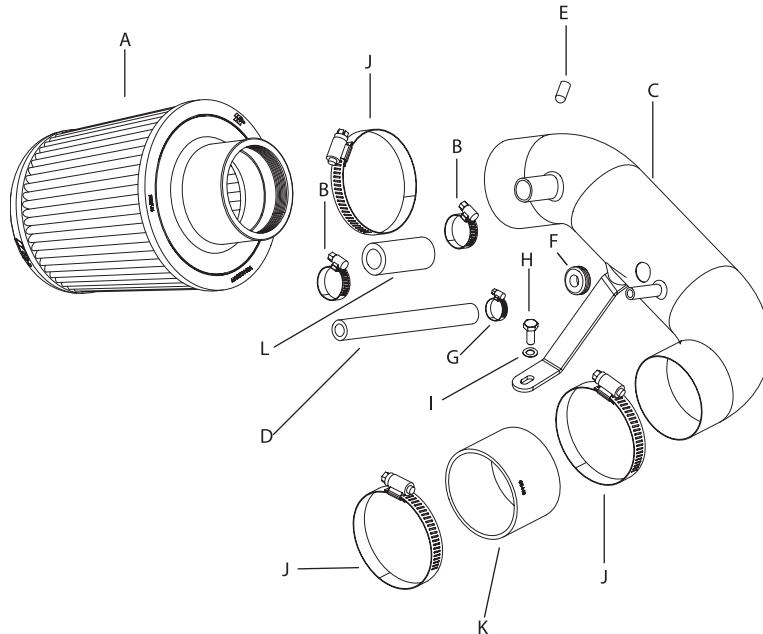

Parts List

A	Air Filter	1	RU-4870
B	Hose clamp, #10, Mini	2	08411**
C	Typhoon Intake Tube	1	27094
D	Hose, 8mm x 6.5"L.	1	084020
E	Rubber Cap	1	08282
F	Grommet	1	08283
G	Hose Clamp, #004	1	21850
H	6mm Hex Bolt, 16mm L.	1	07812
I	6mm Wave Washer	1	08277
J	Hose Clamp, #44, SS	3	08560
K	Silicone Hose	1	084014
L	Hose; 5/8"ID, 2-1/4"L, Rubber	1	08692**

** Used for 2005-06 models years only.

NOTE: FAILURE TO FOLLOW INSTALLATION INSTRUCTIONS AND NOT USING THE PROVIDED HARDWARE MAY DAMAGE THE INTAKE TUBE, THROTTLE BODY AND ENGINE.

TO START:

1. Turn the ignition OFF and disconnect the vehicle's negative battery cable.

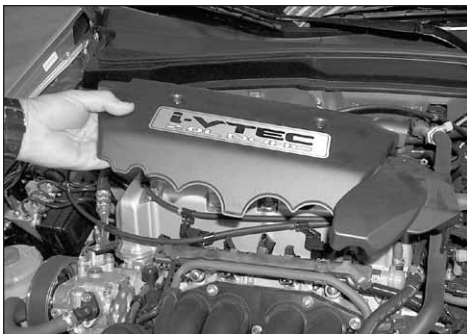

2. Loosen and remove the two bolts that secure the engine cover, then remove the engine cover as shown.

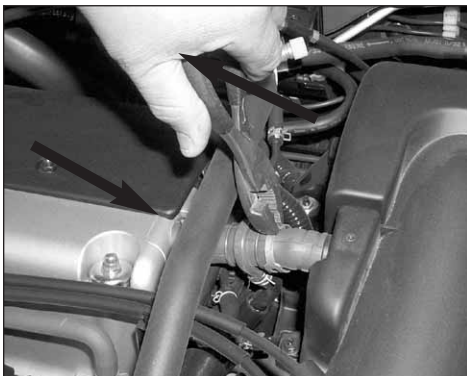

3. Depress and slide the hose clamp off the crank case vent connection at the air cleaner assembly as shown.



4. Depress the hose clamp at the air temperature sensor, then remove the air temperature sensor from the stock intake tube as shown.



5. Disconnect the IA bypass control thermal valve vent hose from the stock intake tube as shown.

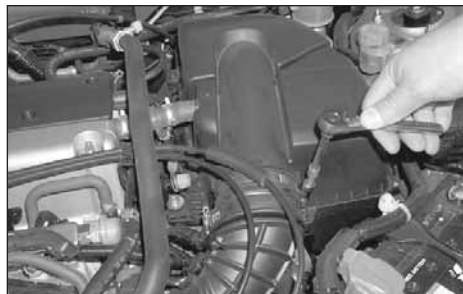

6. Loosen the hose clamp at the air cleaner assembly as shown.



7. Loosen the five bolts that secure the upper air cleaner assembly, then remove the assembly as shown.



8. Remove the one hex nut and loosen the two hex bolts that secure the lower air cleaner assembly, then remove the assembly as shown.



9. Loosen the hose clamp at the throttle body, then remove the stock intake tube as shown.



10. Loosen and remove the hex bolt that secures the air inlet duct as shown.



11. Remove the air inlet duct as shown.



12. Remove the stock IA bypass control thermal valve vent hose as shown.



13. Install the silicone hose and hose clamps onto the throttle body and tighten as shown. NOTE: On 2002-04 model years, advance to step #16.

On 2005-06 Model years ONLY:

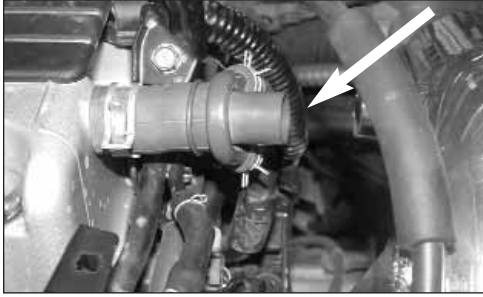

14. On '05-'06 models, remove the stock crankcase vent hose as shown.



15. On '05-'06 models, place hose clamps on each side on 08692 Silicone Hose, as shown.



16. Install the provided grommet into the hole on the K&N intake tube as shown.

NOTE: Before installing the mass air sensor, clean the inside of the tube with water and a towel.



17. Slide the K&N intake tube into the silicone hose on the throttle body, then line up the bracket on the tube with the original air cleaner mounting point as shown.

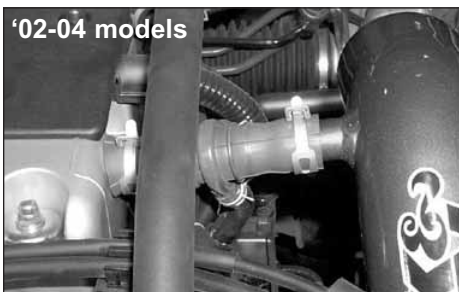

18. Connect the crank case vent hose to the vent on the K&N intake tube and slide the stock hose clamp onto the vent as shown. On 2005-06 model, use supplied hose and hose clamps and tighten.

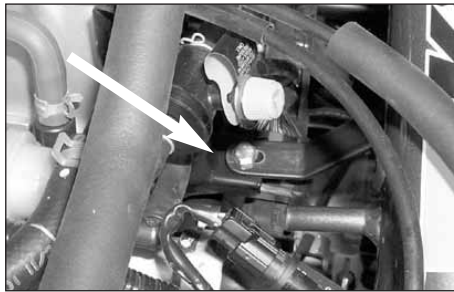

19. Secure the bracket to the original mounting point using the provided hex bolt and wave washer as shown.

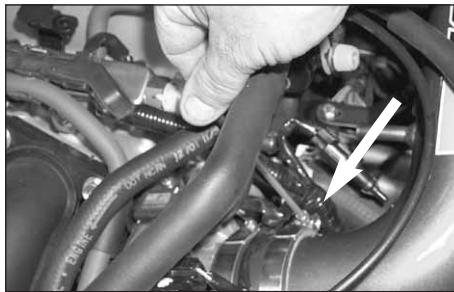

20. Tighten the hose clamp on the K&N intake tube as shown.

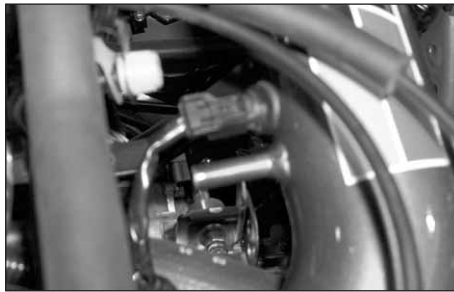

21. Push the air temperature sensor into the grommet in the K&N intake tube as shown.

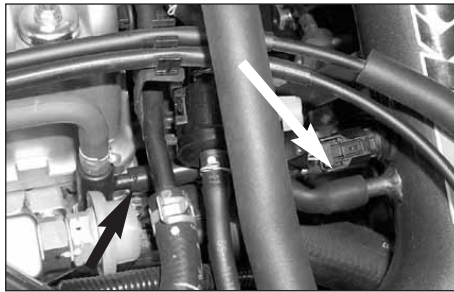

22. Connect the provided silicone hose to the IA bypass control thermal valve, then, connect the other end to the vent on the K&N intake tube as shown. Trim to fit if necessary. Supplied #004 hose clamp provided, can be used for improved seal.



23. Install the K&N air filter onto the K&N intake tube, then, secure with the provided hose clamp as shown.



24. Install the rubber cap plug onto the stand-off on the engine cover as shown.



25. Reinstall the engine cover and secure with the original hex bolts as shown.



26. Re-connect the negative battery cable and double check that everything is tight and properly positioned before starting the vehicle.

27. For 2002-04 model years. The C.A.R.B. exemption sticker, (attached), must be visible under the hood, so that an emissions inspector can see it when the vehicle is required to be tested for emissions. California requires testing every two years, other states may vary.

28. It will be necessary for all Typhoons to be checked periodically for realignment, clearance and tightening of all connections. Failure to follow the above instructions or proper maintenance may void warranty.

ROAD TESTING:

1. Start the engine with the transmission in neutral or park, and the parking brake engaged. Listen for air leaks or odd noises. For air leaks secure hoses and connections. For odd noises, find cause and repair before proceeding. This kit will function identically to the factory system except for being louder and much more responsive.

2. Test drive the vehicle. Listen for odd noises or rattles and fix as necessary.

3. If road test is fine, you can now enjoy the added power and performance from your kit.

4. K&N suggests checking the air filter periodically for excessive dirt build-up. When the element becomes covered in dirt (or once a year), service it according to the instructions on the Recharger service kit, part number 99-5000 or 99-5050.

FREE K&N DECAL To register your warranty, please see us online at knfilters.com/register. FREE K&N DECAL